

B
1

Heavy Duty Sliding Door Hardware

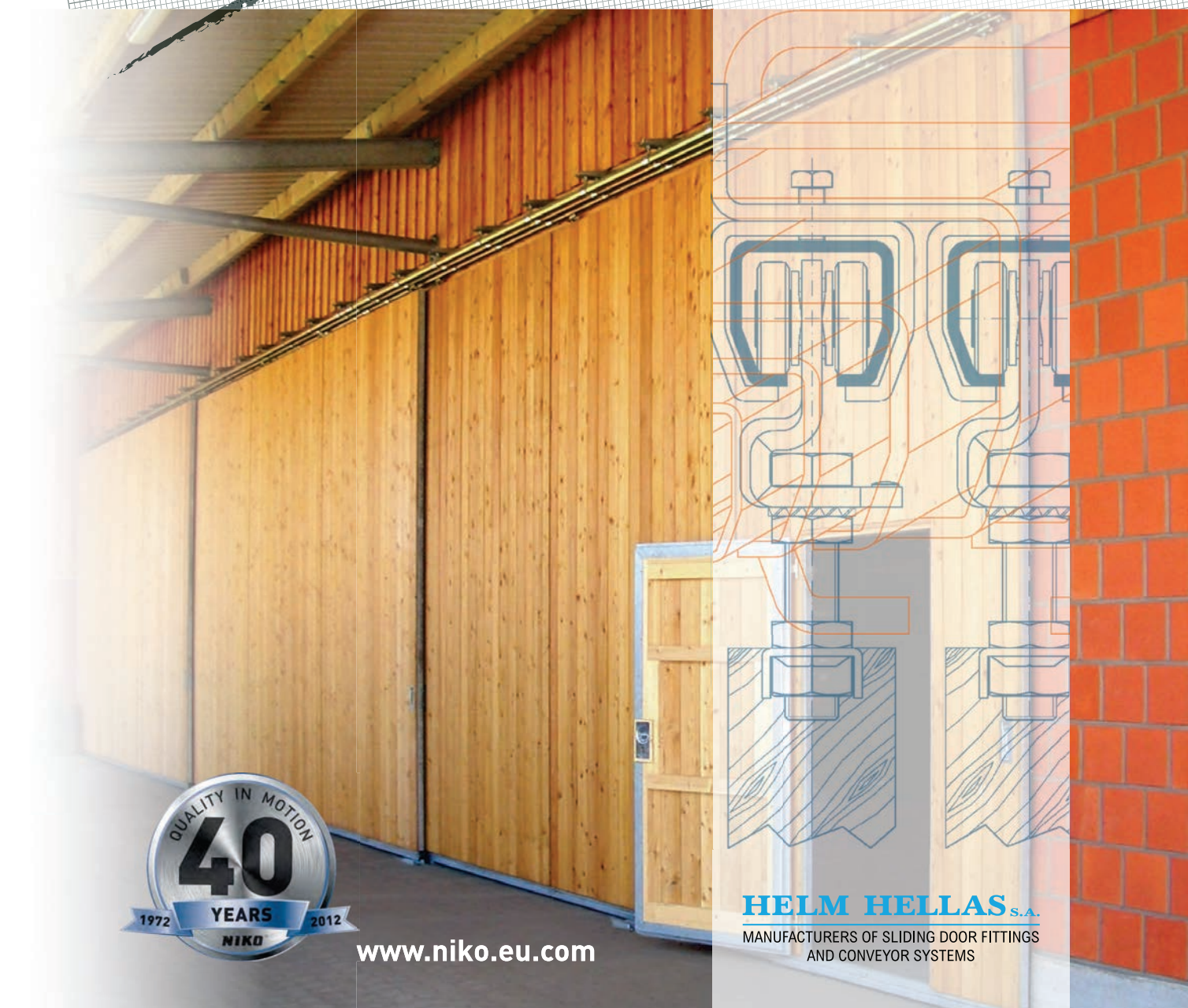

NIKO ... Quality in Motion



www.niko.eu.com

HELM HELLAS S.A.
MANUFACTURERS OF SLIDING DOOR FITTINGS
AND CONVEYOR SYSTEMS

Sliding door fittings up to 2000 kg door weight

Perfection down to the smallest detail

Sliding door fittings from 10 up to 2000 kg door weight.
For this application you can choose from 6 different track profiles.

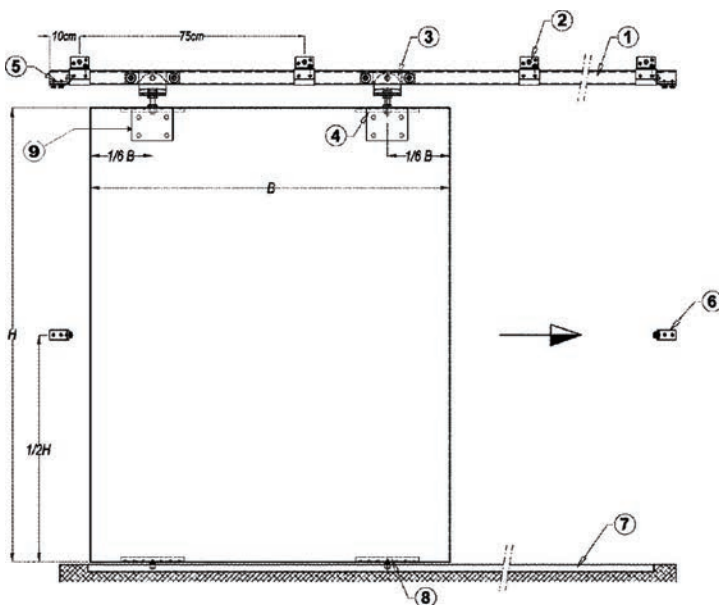
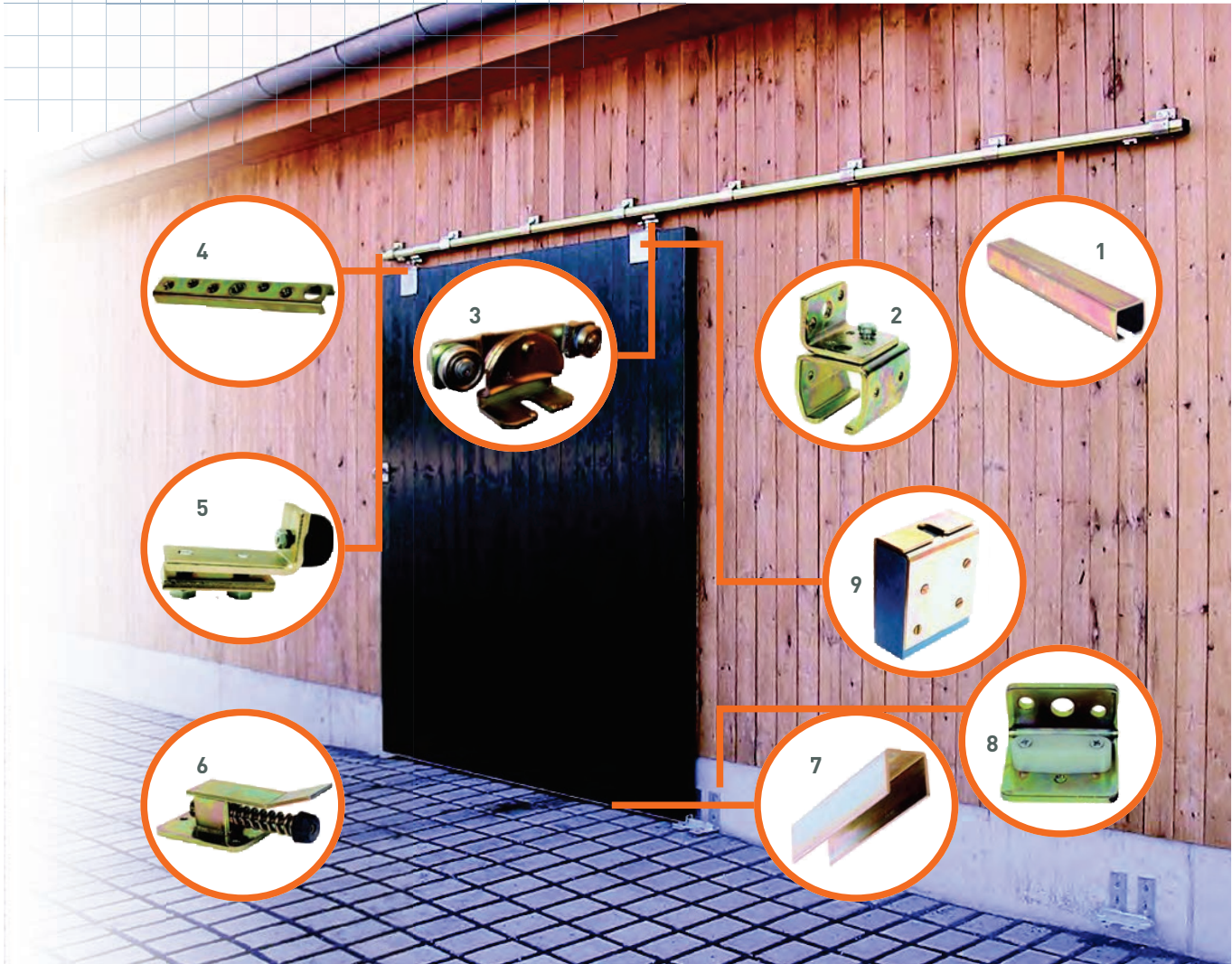

Optimal corrosion protection by EN compliant galvanization. Ongoing quality control through product monitoring according to EN 1527.

- ✓ Stainless steel V2A fittings available
 - ✓ Ammonia resistant bearings available
 - ✓ Different zinc surfaces available
- See our full range of products in our technical catalogue B

- 1 Track
- 2 Wall Support Bracket
- 3 Double Wheel Hanger
- 4 Bracket for wooden constructions
- 5 Track End Stop
- 6 Door End Stop
- 7 Guide Track
- 8 Guide with corner Bracket
- 9 Folding Plate



General Details for track profiles

NIKO Profile No.	Dimensions			
	h (mm)	b (mm)	d (mm)	s (mm)
21.000	28	30	8	1,75
23.000	35	40	11	2,75
24.000	43,50	48,50	15	3,20
25.000	60	65	18	3,60
26.000	75	80	22	4,50
27.000	110	90	25	6,50

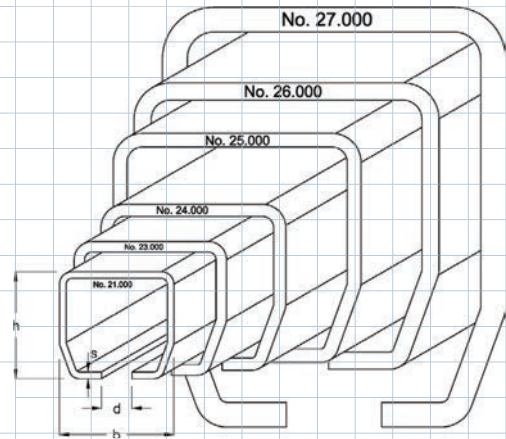

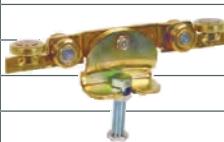
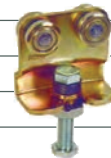



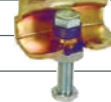









Table with allowed weights for doors

Wheel hangers (single-double)

NIKO Profile No.	Single wheel hanger max. door weight	Double wheel hanger max. door weight	Wheel hanger for electric operation max. door weight	Double wheel hanger for harmonica and folding doors max. door weight
	kg	kg	kg	kg
21.000	60	90	-	22
23.000	 130	 200	 100	 50
24.000	 200	 400	 200	 100
25.000	 400	 600	 300	 150
26.000	 800	 1200	 600	 300
27.000	1400	2000	1200	-



Multi track system
Height adjustable
simply clever

NIKO = PERFECTION IN DETAIL!

- ✓ Our products are continuously adapted to the requirements of the market.
- ✓ We sell more than 1,000 products in the sliding door fittings range.
- ✓ We also offer fittings for harmonica & folding doors
- ✓ Sliding wall systems with parking area

PLEASE SEND REQUEST FOR OUR DOCUMENTATION.



AUSTRIA

NIKO Vertriebs GmbH

Hainfelderstraße 3
A – 2564 Weissenbach
Tel. 0043 (0) 2674 81005
Fax 0043 (0) 2674 81006
office.at@niko.eu.com

GERMANY

NIKO Technik GmbH

Friedrichstraße 269 A
D – 42551 Velbert
Tel. 0049 (0) 2051 6047 36
Fax 0049 (0) 2051 6047 38
office.de@niko.eu.com

GREECE

Helm Hellas S.A.

82nd Km Athens-Korinthos
P.O. Box 209
201 00 KORINTHOS
Tel. 0030 (0) 27410 85803-6
Fax 0030 (0) 27410 25368
info@niko.eu.com

UNITED KINGDOM

NIKO Ltd

Unit 12 Southfield Road
Kineton Road Ind. Est. Southam
Warwickshire – CV47 OLT – UK
Tel. 0044 (0) 1926 813111
Fax 0044 (0) 1926 815599
Sales@niko-ltd.co.uk

USA

NIKO Track

300 Highpoint Ave
Portsmouth, RI. 02871 USA
Tel. 001 (0) 401 683 7525
Fax 001 (0) 401 683 6450
Sales@NikoTrack.com

TRADITION IS PROGRESS PRESERVED, PROGRESS IS TRADITION CONTINUED.

Helm Hellas 1972 – 2012

A family business for 40 years, Helm Hellas has been built on the twin foundations of Tradition and Progress, always heading towards a successful economic future.

QUALITY IS THE RESULT OF ATTENTION TO DETAIL.

Quality will always be as standard for us, our products, our staff and our partners.

OUR VISION.

We are an international company and our goal is to be market leaders in each of our business sectors.

OUR VALUES

- ✓ We want to offer our customers the best quality at a reasonable price.
- ✓ We strive for continual improvement in our quality procedures – because we believe the company that doesn't move forward will be left behind.
- ✓ We respond to any demand on the market with the ongoing development of new products.
- ✓ We support our co-workers by ensuring they are highly motivated and well qualified.
- ✓ We want to expand into new sales markets to continue to win satisfied customers.

www.niko.eu.com

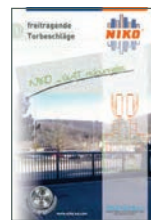

Your **NIKO** agent will be happy to advise you:



Complete product range **NIKO**:

- A1 – Residential Sliding Door Hardware
- A2 – Sliding Curtains Hardware
- B1 – Heavy Duty Sliding Door Hardware
- B2 – Folding and Harmonica Door Hardware
- B3 – Garage Door and Door around the corner Hardware
- C1 – Overhead Conveyor Systems
- C2 – Light Crane Systems
- C3 – Cable Trolleys and Festoon Systems
- C4 – Personal Fall Arrest Systems (EN 795)
- D – Sliding Gate Hardware

Copyright NIKO 2011

We take no obligation for layout, composition, technical modifications as well as misprints.